

TRACK 230V

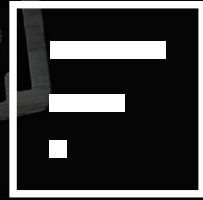

FLUX

FUTURE LIGHT UNIVERSAL XPERIENCE

T230-930-B



APPLICATIONS

ARCHITECTURAL
RETAIL

FEATURES

CUT-TO SIZE
MODULAR DESIGN
MULTIPLE INSTALLATION OPTIONS
SAFETY & COMPLIANCE
HIGH-QUALITY CONSTRUCTION
AESTHETIC & ARCHITECTURAL APPEAL



For more information please check our website www.fluxitalia.com
or contact us tel.+39 071 0960086 email: info@fluxitalia.com

Via armando cingolani, 13 Zona ind.le Sambucheto di Recanati 62019 Recanati (MC) - Italy

PRODUCT INFO

T230-930-B



TECHNICAL DATA

LENGTH	1000mm - 2000mm- 3000mm
MATERIAL	Aluminium / Copper / PC
COLOURS	Black RAL9017
WEIGHT	800 g/m
FASTENING	Surface; Suspended
FREQUENCY	50/60Hz
LOAD ON PHASE	8-12A
DIMENSION (mm)	32.2 x 35.6
CERTIFICATIONS	CE / LVD / EMC

DRAWINGS

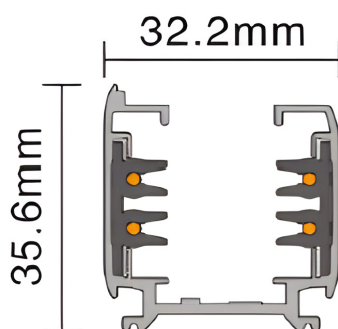

ACCESSORIES

T230-930-B

ELECTRICAL JOINT

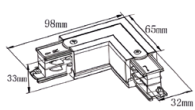
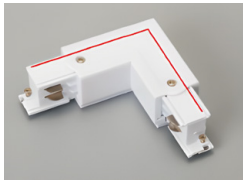

L JOINT

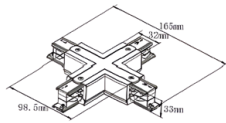
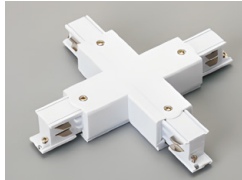

X JOINT

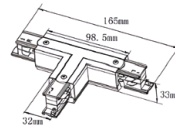
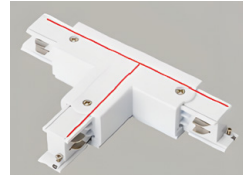

T JOINT

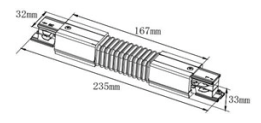

FLEXIBLE JOINT

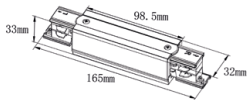

STRAIGHT JOINT

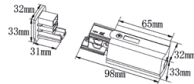

END FEEDER
END CAP

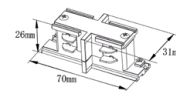

GHOST JOINT

FIXING SYSTEM



SUSPENDED



CEILING

