

F
L
U
X

S
R
L

EASY80 MAGNET-32



Sede Legale:

Via Brigata Macerata, 70 - 62100
MACERATA – ITALIA
P.I. IT 01997820434 -
REA: MC-253306
T. +39.071.0960074
info@fluxitalia.com
www.fluxitalia.com

PRODUCT SERIES EASY MAGNET

LIGHT SOURCE

LED TYPE	COB
POWER MAX	30W
LUMINOUS FLUX	2842LM
LUMINOUS EFFICIENCY(LM/W)	111LM/W
ENERGY EFFICIENCY INDEX	A+
COLOUR RENDERING INDEX(RA)	CRI>90
LED COLOUR TEMPERATURE(K)	3000K-3200K 3500K-4000K
STEP McADAM	SDCM 2
AVERAGE OPERATIONAL LIFE	30.000 HRS

OPTIC

REFLECTOR	PLASTIC REFLECTOR
BEAM ANGLE	14°-24°-36°
LIGHT DISTRIBUTION SYMMETRY	SYMMETRIC
ACCESSORIES	FRESNEL LENS FROSTED LENS HONEYCOMB SNOOTER

LED FIXTURE

HOUSING	ALUMINIUM
FINISH/ COLOUR	MATTE WHITE/MATTE BLACK/ SILVER GREY CUSTOMIZED RAL COLOUR (on request)
IP PROTECTION GRADE	IP20
INSULATION CLASS	CLASS III

ELECTRICAL FEATURES

DRIVER	REMOTE
FIXED OR DIMMABLE	PUSH/1-10V/DALI
FOR EMERGENCY LIGHTING	SUITABLE
CONNECTION	700MA

MECHANICAL FEATURES

DIMENSIONS (MM)	D80XH130MM
WEIGHT	0.900KGS
TYPE OF INSTALLATION	MAGNET BASE ARM32
APPROVAL	UL E514245 CB CE ROHS



TECHNICAL DATA

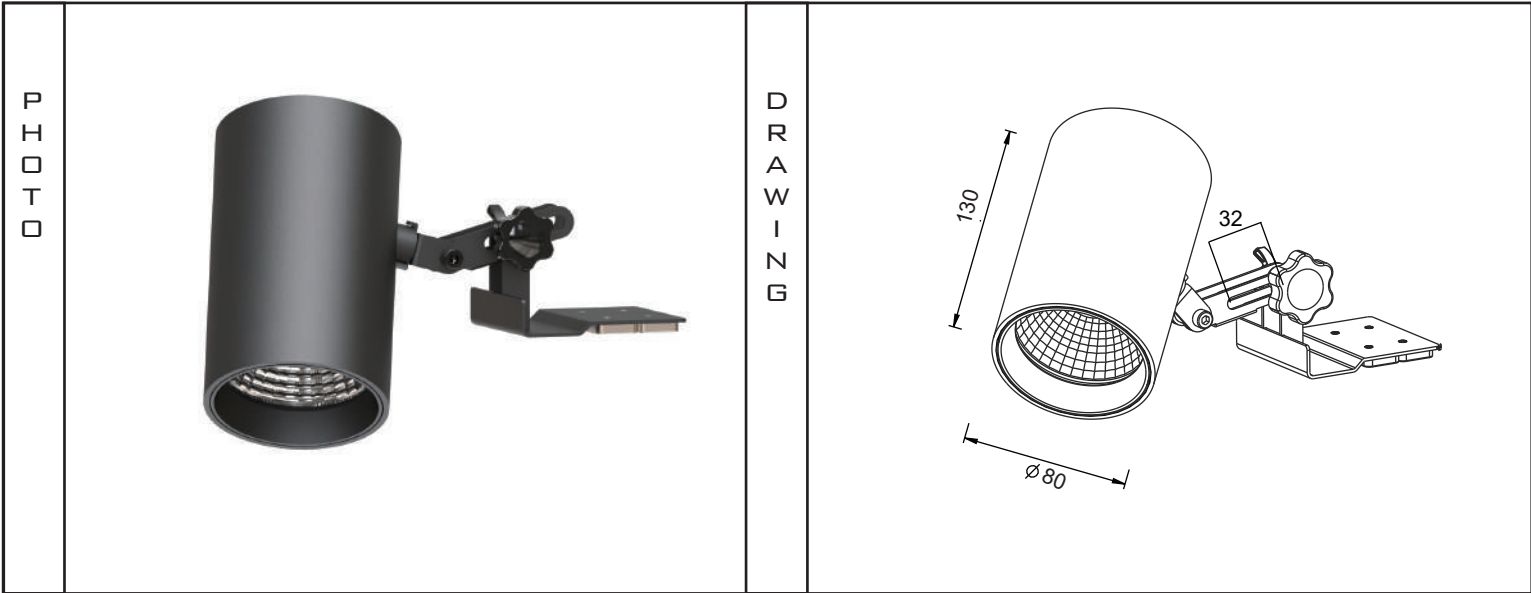

ACCESSORIES



FRESNEL



FROSTED

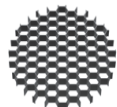

HONEYCOMB



SNOOTER

OPTIC & PHOTOMETRIC DATA



S-Spot
q 9°-15°

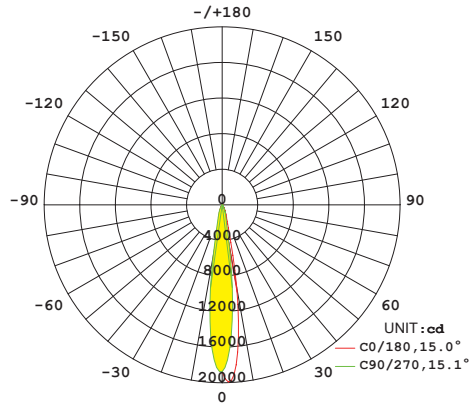

AVERAGE BEAM ANGLE(50%): 15.1 DEG

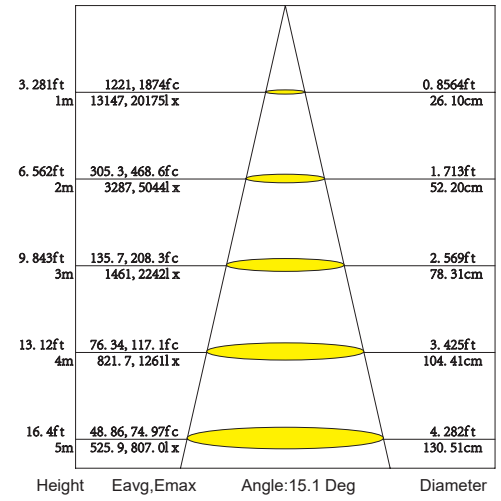

14° 30W 3500K RA>90 CLEAR LENS



M-Medium
q 16°-25°

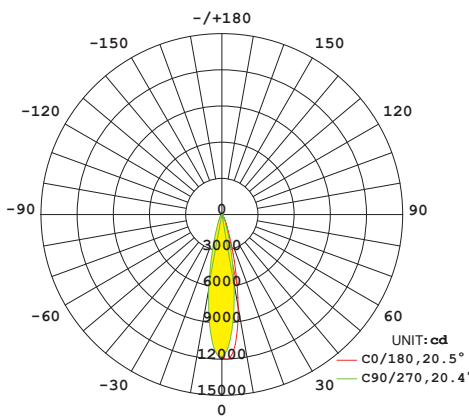

AVERAGE BEAM ANGLE(50%): 20.5 DEG

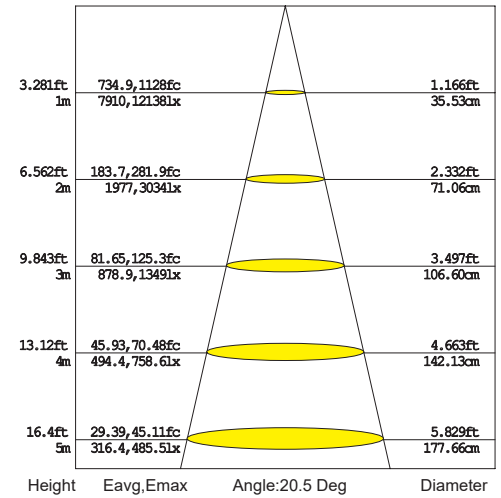

24° 30W 3500K RA>90 CLEAR LENS



F-Flood
q 36°-39°

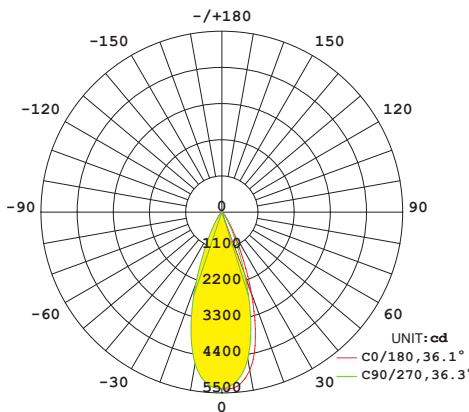

AVERAGE BEAM ANGLE(50%): 36.2 DEG

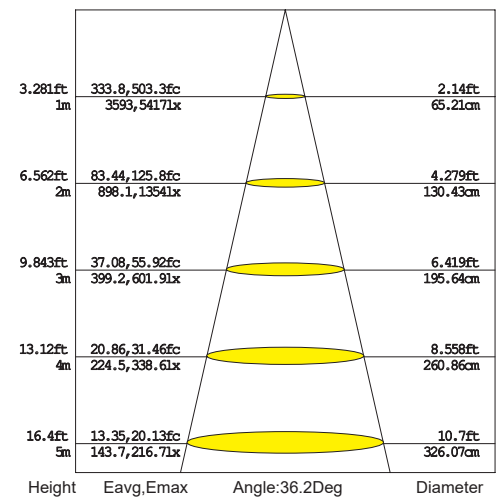

36° 30W 3500K RA>90 CLEAR LENS